

VERTICAL PLATE CLAMPS 500kg TO 5 tonne

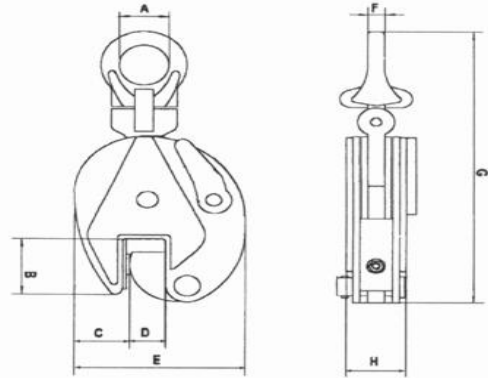

- ◆ Hardened steel jaws
- ◆ Locking mechanism
- ◆ Hinged attachment
- ◆ Fully serviceable
- ◆ Larger sizes available up to 12t



Product code	Capacity (Tonne)	A (mm)	B (mm)	C (mm)	D (mm)	E (mm)	F (mm)	G (mm)	G (mm)	Weight (kg)
VPC0.5T	0.50	30	43	35	0-15	105	10	218	45	2
VPC1T	1	48	63	51	0-20	145	12	305	63	5
VPC2T	2	68	76	59	0.25	175	16	368	68	7.5
VPC3T	3	74	85	56	0-30	218	20	395	90	15.5
VPC5T	5	80	90	65	0-52	240	222	450	88	22

HORIZONTAL PLATE CLAMPS



- ◆ Industrial Quality
- ◆ Quick & Easy Installation
- ◆ Locking Mechanism
- ◆ Larger Sizes available

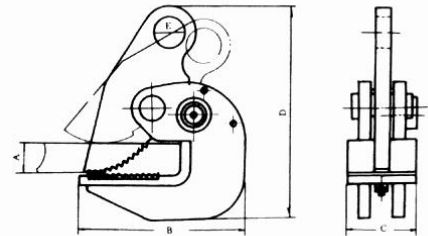

Product code	Capacity		Jaw Opening (mm)	A max	B (mm)	C (mm)	D (mm)	E (mm)
	Each	Pair						
HPC0.75T	750kg	1.5 tonne	0-25	25	125	50	175	25
HPC1.5T	1.5 tonne	3 tonne	0-30	30	157	65	204	30
HPC2.5T	2.5 tonne	5 tonne	0-45	45	231	90	310	40

PIPE LIFTING HOOKS



- ◆ Pipe lifting hook with surface Protection
- ◆ Easy to Operate
- ◆ Used In Pairs

Product code	W.L.L. Per Pair (in tonnes)	Max Pipe Wall Thickness (mm)
PIPE-HOOK-01786	3	40
PIPE-HOOK-01788	6	50
PIPE-HOOK-01789	8	70